

# Motor 790 Duke 2024



ART.-NR.: P2C9006R00K24EN



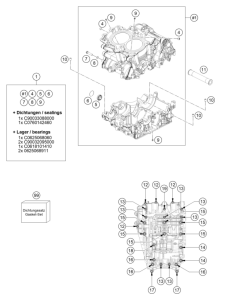
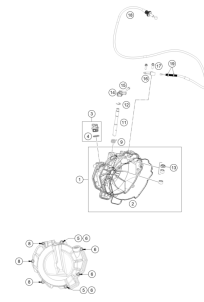
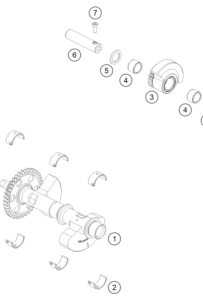
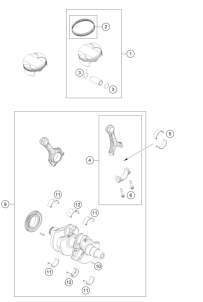
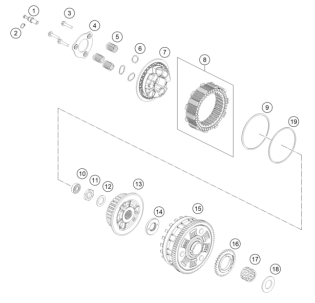
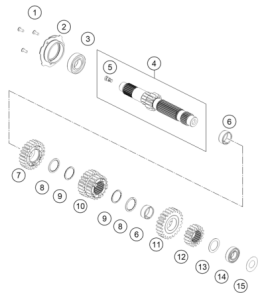
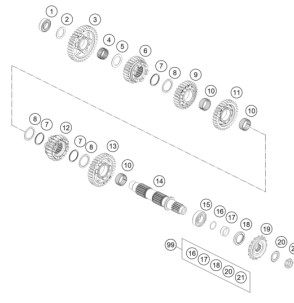
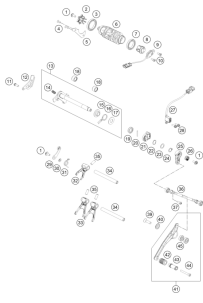
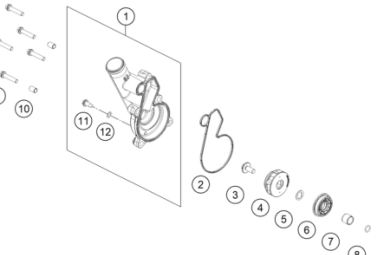
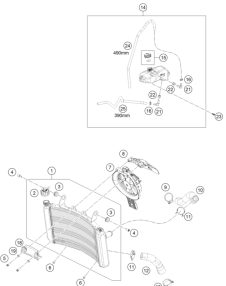

All information contained is without obligation. KTM Sportmotorcycle GmbH particularly reserves the right to modify any equipment, technical specifications, prices, colors, shapes, materials, services, service work, constructions, equipment and the like so as to adapt them to local conditions or to cancel any of the above items, all without previous announcement and without giving reasons. KTM may stop manufacturing certain models without previous notice. KTM shall not be held liable for any deviations of availability and/or ability to deliver, illustrations, descriptions, printing and/or other errors. The illustrated models partly contain extra equipment, which is not applied to standard models.

© by KTM Sportmotorcycle GmbH, Mattighofen AUSTRIA; All rights reserved; Reprint, also in extracts, with written allowance of KTM Sportmotorcycle GmbH, Mattighofen only.

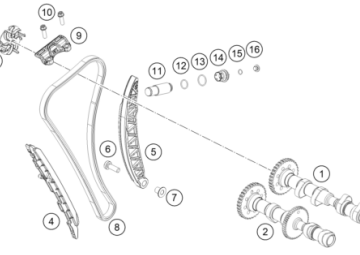
<p><b>ENGINE CASE</b></p>  <p><b>3</b></p>	<p><b>CLUTCH COVER</b></p>  <p><b>4</b></p>	<p><b>BALANCER SHAFT</b></p>  <p><b>5</b></p>	<p><b>CRANKSHAFT, PISTON</b></p>  <p><b>6</b></p>
<p><b>CLUTCH</b></p>  <p><b>7</b></p>	<p><b>TRANSMISSION I - MAIN SHAFT</b></p>  <p><b>8</b></p>	<p><b>TRANSMISSION II - COUNTERSHAFT</b></p>  <p><b>9</b></p>	<p><b>SHIFTING MECHANISM</b></p>  <p><b>10</b></p>
<p><b>WATER PUMP</b></p>  <p><b>12</b></p>	<p><b>COOLING SYSTEM</b></p>  <p><b>13</b></p>	<p><b>VALVE DRIVE</b></p>  <p><b>14</b></p>	<p><b>TIMING DRIVE</b></p>  <p><b>15</b></p>

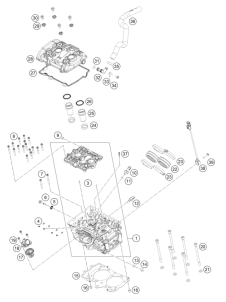
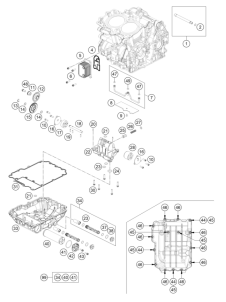
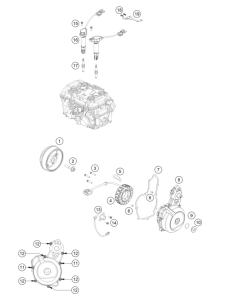
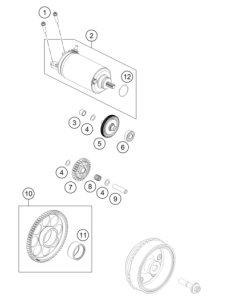
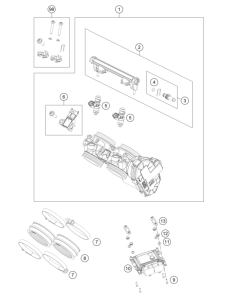
<p><b>CYLINDER HEAD</b></p>  <p><b>16</b></p>	<p><b>LUBRICATING SYSTEM</b></p>  <p><b>17</b></p>	<p><b>IGNITION SYSTEM</b></p>  <p><b>19</b></p>	<p><b>ELECTRIC STARTER</b></p>  <p><b>20</b></p>
<p><b>THROTTLE BODY</b></p>  <p><b>21</b></p>			

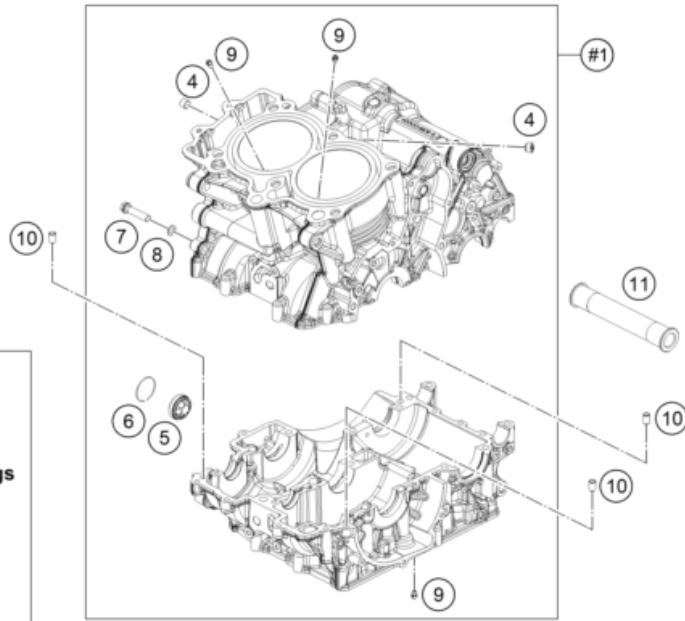

- 1
- |    |   |   |   |
|----|---|---|---|
| #1 | 4 | 5 | 6 |
| 7  | 8 | 9 |   |
- + Dichtungen / sealings**  
 1x C90033088000  
 1x C0760142460
- + Lager / bearings**  
 1x C0625068060  
 2x C90032095000  
 1x C0618101410  
 2x 0625068911

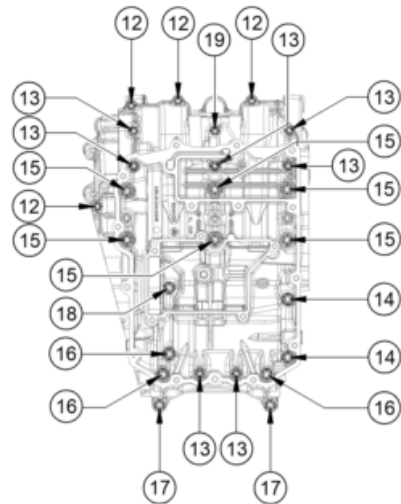

POS	PARTNUMBER		PIECE
1	C9003000024424	Engine case compl.	1
4	0906100100	pipe plug DIN 906 M10x1	2
5	C59030019200	oil level viewer	1
6	61030019050	CIRCLIP OIL LEVEL GLASS 03	1
7	C0000250803500	HH collar screw M8x35 TX40	1
8	C0603082131	Cu ring d8,2/13/1	1
9	C90030063070	oil jet 70 M5	3
10	C90030024000	Dowel	3
11	C63530010000	housing socket	1
12	C00002506030U0	Hex collar screw M6x30 ISA40 with washer	4
13	C00002506060U0	Hex collar screw M6x60 ISA30 with washer	7
14	C0000250809000	SK-Bundschräube M8x90 ISA40	2
15	C00002508090U0	Hex collar screw M8x90 ISA40 with washer	6
16	C0000250806500	SK-Bundschräube M8x65 ISA40	3
17	C0000250805500	SK-Bundschräube M8x55 ISA40	2
18	C0000250804500	SK-Bundschräube M8x45 ISA40	1
19	C00002508065U0	Hex collar screw M8x65 ISA40 with washer	1
99	C90030099000	Engine gasket kit	1

216353011

69087

\* NEW PART

X ON DEMAND

# CLUTCH COVER

Motor 790 Duke 2024

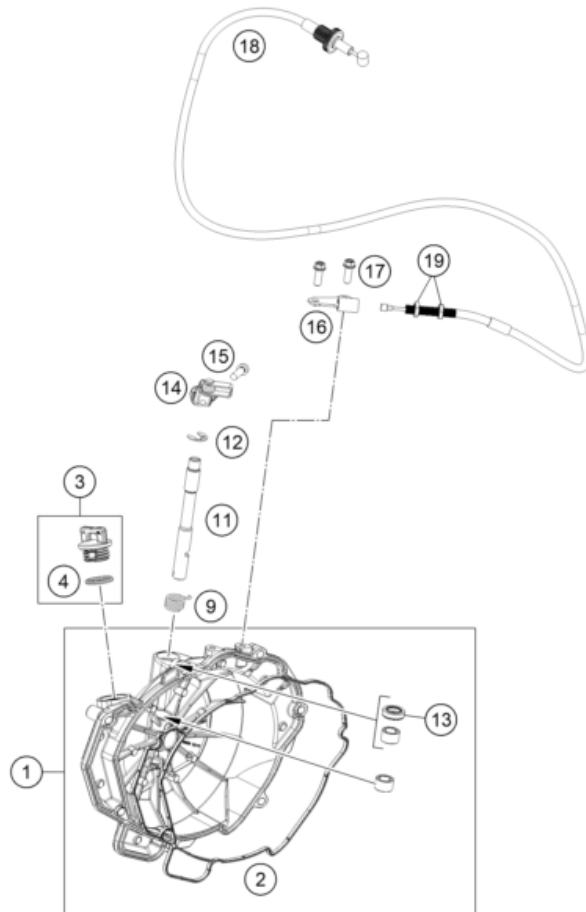

POS	PARTNUMBER		PIECE
1	C9003020114441	Clutch cover cpl.	1
1	C9003010114441	Clutch cover cpl. KTMR2R only for CN	1
2	C90030025100	Form ring, clutch cover	1
3	C90030020100	oil plug cpl. M24x3	1
4	C0770191015	O-ring 19x3 NBR	1
5	C90030024000	Dowel	2
6	C0000250603500	SK-Bundschrabe M6x35 ISA30	4
8	0025060256	HH collar screw M6x25 TX30	3
9	C90032048003	clutch release lever spring	1
11	63532149000	Clutch release shaft	1
12	C0799090003	retaining washer DIN 6799 - 9	1
13	C0760122060	Shaft seal ring 32x45x6.5	1
14	C90032148033	Release lever assembly cpl.	1
15	C014580060206S	Cyl. screw ISO 14580 M6x20 SS	1
16	C63532052100	Cable retaining bracket	1
17	C0000250601600	HH collar screw M6x16 TX30	2
18	C90102090000	Clutch cable	1
19	C0934080006	Hexagonal nut DIN 934 M8	2

216353020

69188

\* NEW PART

X ON DEMAND

# BALANCER SHAFT

Motor 790 Duke 2024

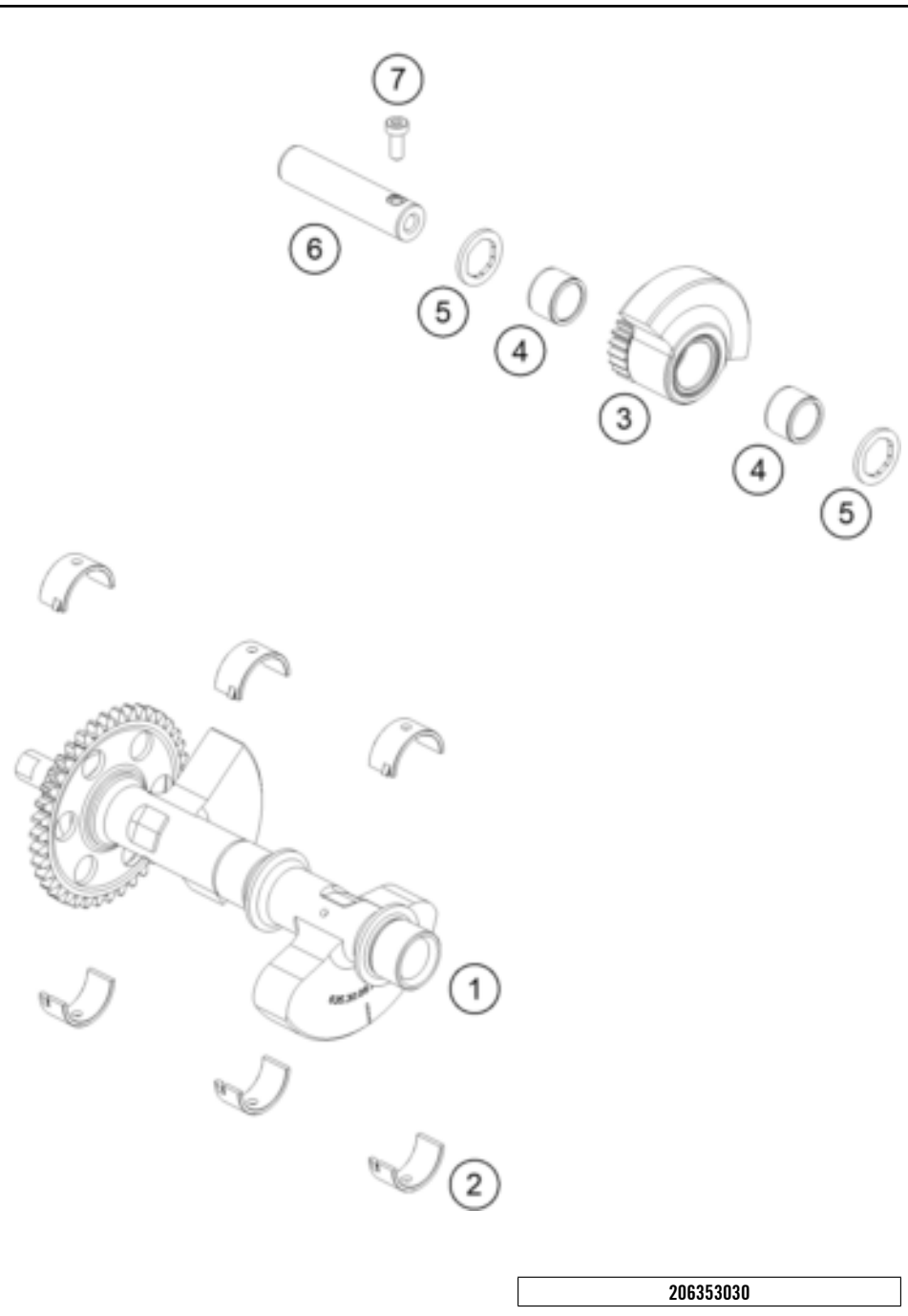

POS	PARTNUMBER		PIECE
1	63530057144	Balancer shaft cpl.	1
2	C90030157050	Bearing Shell 22/26/13	6
3	63530059200	Counter Balancer shaft cpl.	1
4	0405151913	needle roller and cage assy. K 15x19x13	2
5	C63530059060	thrust washer 15.5/22.5/2	2
6	C63530059150	Bearing bolt	1
7	C0079840501200S	Zyl.Schraube DIN6912 M5x12 8.8	1

206353030

69090

\* NEW PART

X ON DEMAND

# CRANKSHAFT, PISTON

Motor 790 Duke 2024

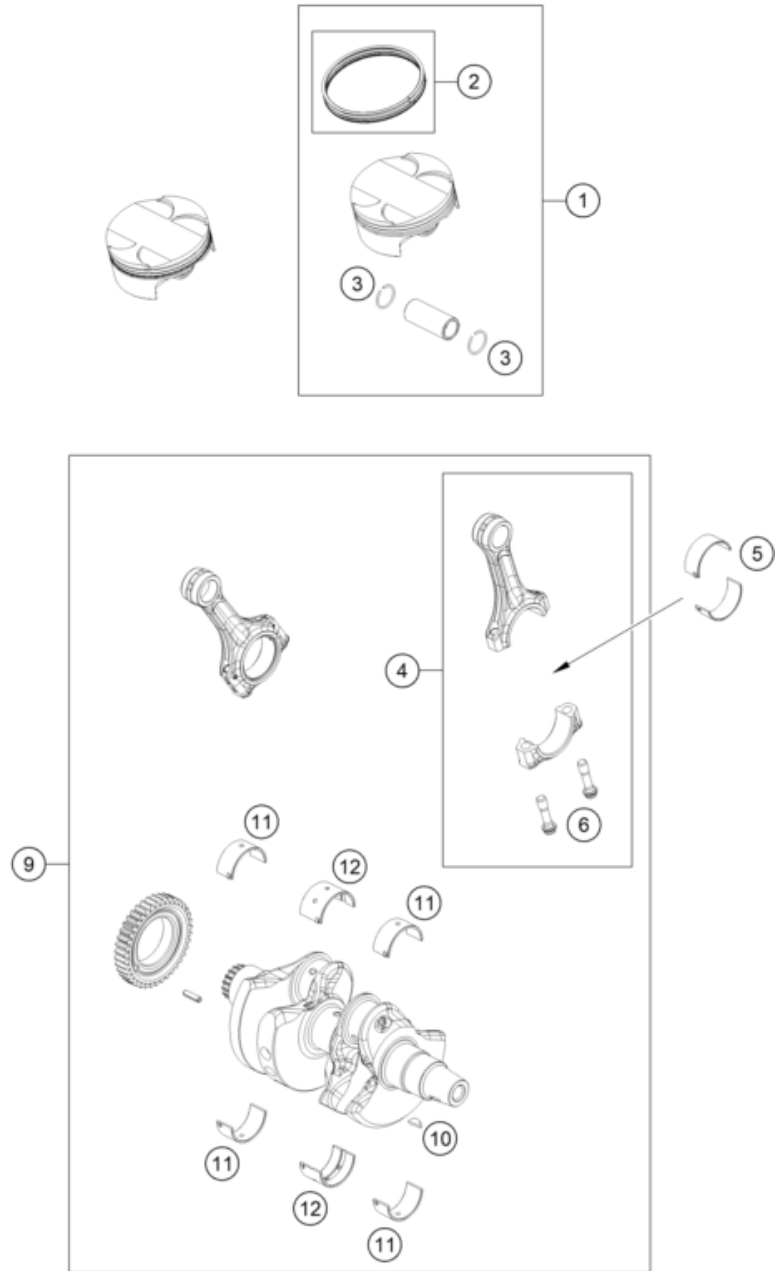

POS	PARTNUMBER		PIECE
1	C90030107000	Piston cpl.	2
2	C90030131044	Piston Ring Set D=88mm	2
3	63530074000	Circlip	4
4	C90030015000	connecting rod cpl. (110mm)	2
5	C900300140001	Conrod bearing shell, blue 38x41x16	x
5	C900300140002	Conrod bearing shell, red 38x41x16	x
6	63630013000	Connecting rod screw, M8x0.75	4
9	C90030018244	Crankshaft assembly	1
10	C0888040050	woodruff key DIN 6888 4x5x13	1
11	C900300820001	Main bearing, blue 38x42x18	x
11	C900300820002	Main bearing, red 38x42x18	x
12	C900301820001	Main bearing, blue 38x42x25	x
12	C900301820002	Main bearing, red 38x42x25	x

186353060

59486

\* NEW PART X ON DEMAND



# CLUTCH

# Motor 790 Duke 2024

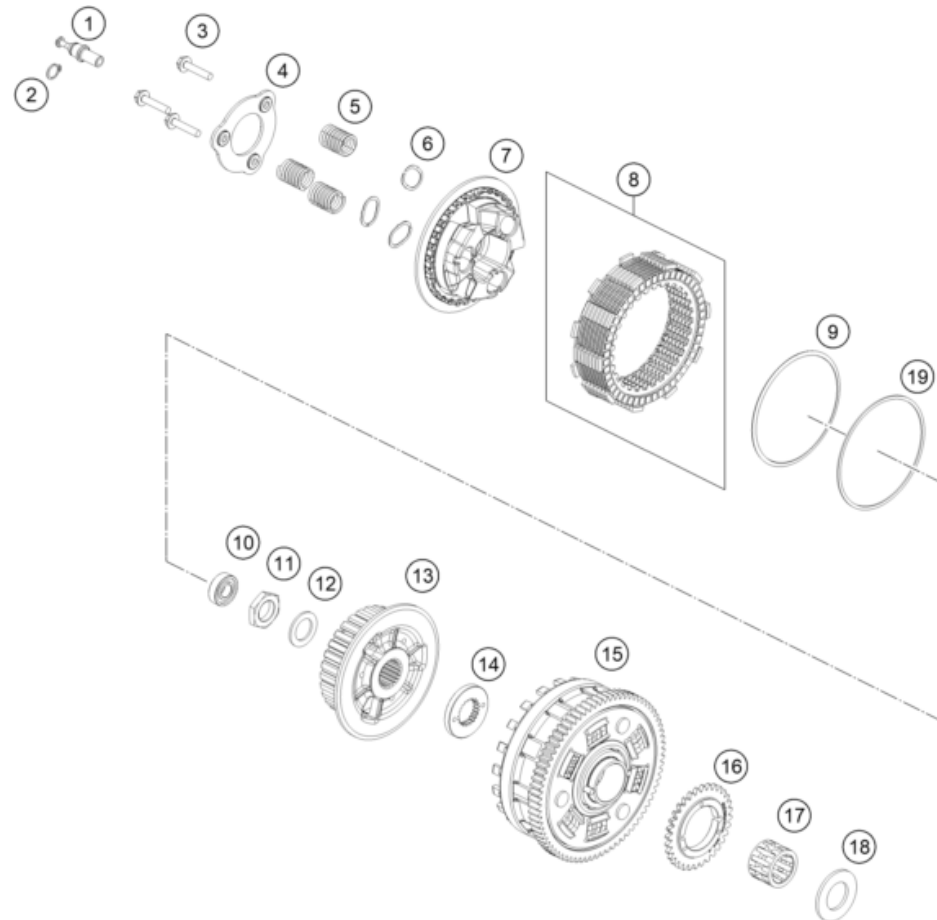

POS	PARTNUMBER		PIECE
1	C63532048104	tension bolt	1
2	C0471120010	retaining ring DIN 471 12x1	1
3	63532044000	Collar screw M6x30	3
4	63532006000	Arrestor Pressure Cap	1
5	63532005000	Clutch spring	3
6	63532041000	Clutch spring cover	3
7	63532003000	Pressure Plate	1
8	63532011010	Disc Pack	1
9	63532034000	Belleville Spring	1
10	0625060017	BALL BEARING 6001.2URS.C3	1
11	C90036073150	hex nut M20x1., H=6mm	1
12	0252012103100	Wedge lock washer HLS 20	1
13	63532002000	center clutch	1
14	63532021000	Spline Washer	1
15	63532001044	Clutch Cage cpl.	1
16	C90038001232	Oil pump gear 32th	1
17	0405263525	Needle bearing PK26x35x24.8	1
18	C90032020000	Washer, 26/47/2.8	1
19	63532035000	Seat Judder Spring	1

186353210

59487

\* NEW PART

X ON DEMAND

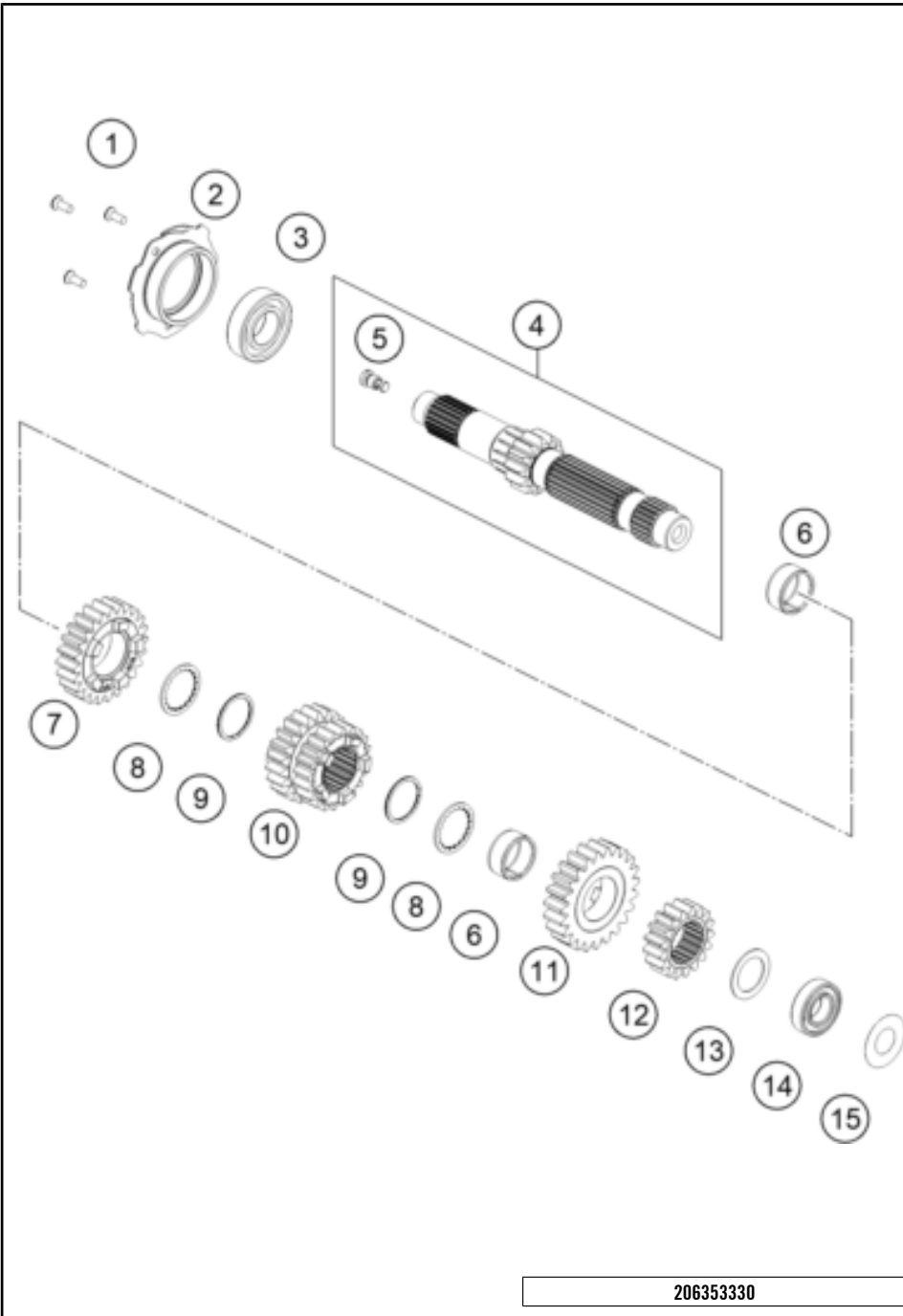

POS	PARTNUMBER		PIECE
1	C010642060166S	Hex screw ISO10642-M6x16 self-locking	3
2	C90030068000	Bearing flange	1
3	0625062280	ball bearing 62/28 CM	1
4	63633001044	Main shaft preassembled	1
5	63533001030	reducing jet Ø0.3mm M8	1
6	0405242813G	NEEDLE BEAR.K 24X28X13 DIVIDED	2
7	63633005000	Idle gear 5th gear	1
8	63533045000	toothed washer	2
9	0471026000	circlip d26	2
10	63633003000	Sliding gear 3rd/4th gear	1
11	63633006000	Idle gear 6th gear	1
12	63533002000	Solid gear 2. G	1
13	63533032000	stop disc 22.2/31.7/1	1
14	0625068911	Grooved ball bearing 22x45x12 C4H	1
15	C90033088000	sealing washer 22x44x0.2	1

206353330

59490

\* NEW PART

X ON DEMAND

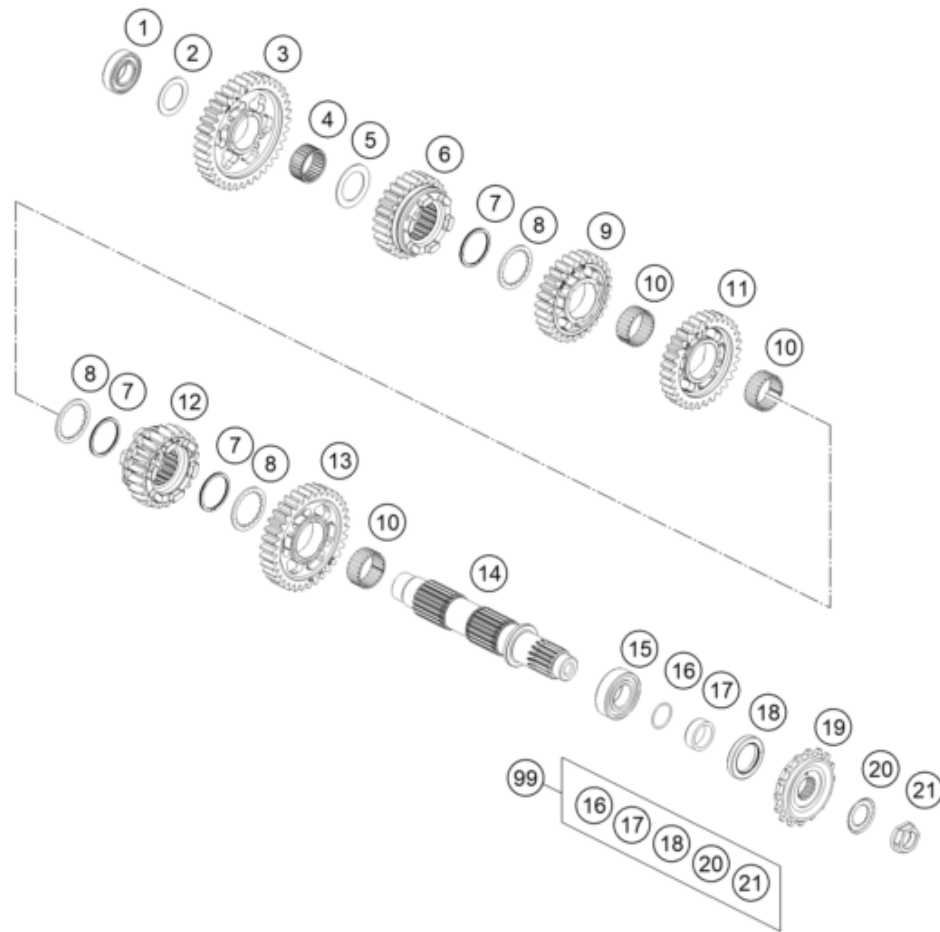

POS	PARTNUMBER		PIECE
1	0625068911	Grooved ball bearing 22x45x12 C4H	1
2	63533032000	stop disc 22.2/31.7/1	1
3	63533011000	Idler Gear 1. G	1
4	0405242813	NEEDLE BEAR. K 24X28X13 TN	1
5	63533034000	stop disc 24.3/35.75/1	1
6	63633015000	Sliding gear 5th gear	1
7	0471029000	TWISTED CIRCLIP D29	3
8	63533033000	Stop Disc 27/36/1.5	3
9	63633014000	Idle gear 4th gear	1
10	0405263013G	needle bearing 26x30x13 splite	3
11	63633013000	Idle gear 3rd gear	1
12	63633016000	Sliding gear 6th gear	1
13	63533012000	Idler Gear 2. G	1
14	63533010000	Output shaft	1
15	49030023000	cylindrical roller bearing NJ205	1
16	C0770020220	O-RING 25,12X1,78 NBR70	1
17	C63533030011	Wear bushing, sprocket 11 mm	1
18	0760003247000	Shaft seal ring 32x47x7 AS-P FPM80	1
19	C90033029116	front sprocket 16 teeth damped	1
20	C90033031000	Lock washer	1
21	C90033032300	Sprocket nut M20x1.5	1
99	C00050000992	Repair kit countershaft	x

186353360

59491

\* NEW PART

X ON DEMAND

# SHIFTING MECHANISM

Motor 790 Duke 2024

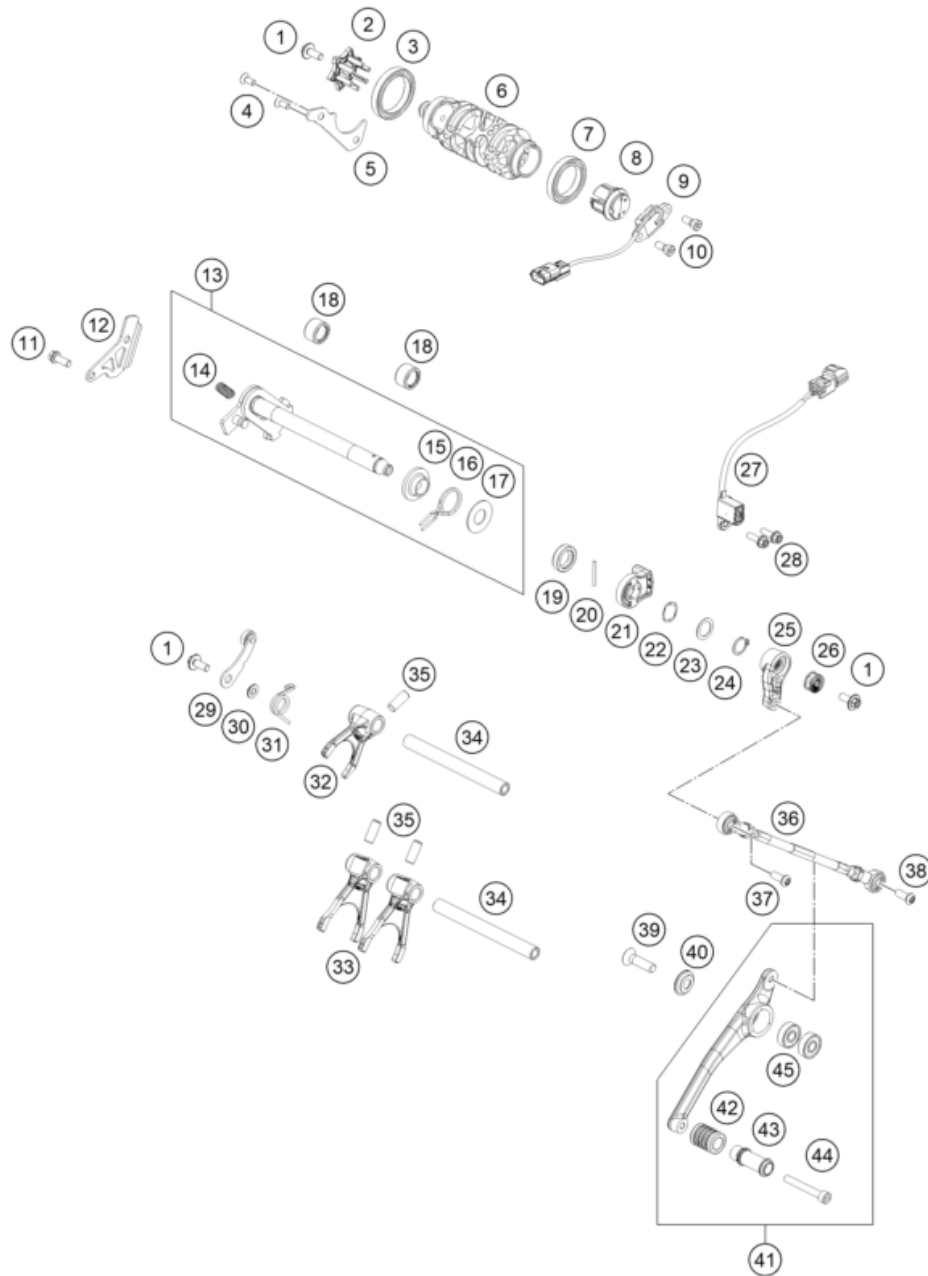

206353411

POS	PARTNUMBER		PIECE
1	C0000240601500S	HH collar screw M6x15 TX30	1
2	C90034015000	Shift star	1
3	C0625068070	deep groove ball bearing 6807	1
4	C0000190501200S	INT. TORX FLAT HEAD M5X12 T25	2
5	C90034011200	Bearing retaining bracket	1
6	63534012001	shift drum 6G	1
7	C0625068060	deep groove ball bearing 6806 C3	1
8	C90034012020	magnet holder cpl.	1
9	C90011023100	Gear position sensor	1
10	0984050123S	CYLIND. SCR. DIN912 M5X12 8.8	2
11	C0000250601600S	HH collar screw M6x16 TX30 SL	1
12	C90033022000	bearing retaining plate	1
13	63534005033	shift cpl.	1
14	56534013100	TENSIONING SPRING 0,8MM	1
15	54634020000	SPRING GUIDE	1
16	61234014000	RETURNSPRING 2MM	1
17	54634050000	STOP DISK 14X30X1	1
18	C90032095000	needle sleeve HK 1412 14x20x12	2
19	C0760142460	radial shaft seal 14x24x6 B	1
20	C0007025241	dowel pin DIN 7 A1 2.5m6x24	1
21	C90034050000	magnet holder	1
22	63534050010	wave spring Smalley SSB-0075-S17	1
23	C0988142005	Thrust washer DIN 988 14x20x0.5	1
24	C0471140100	retaining ring DIN 471 14x1	1
25	6413403000033	Pull Rod	1
26	C90033041500	Nordlock washer M6	1
27	C90034051100	Shift assistant sensor	1
28	C0000250601600S	HH collar screw M6x16 TX30 SL	2
29	C63534024000	detent arm cpl.	1
30	C63534052000	step washer	1
31	C90034023000	Detent arm spring	1
32	63534002000	shift fork 5-6 gear	1
33	63534001100	Shift fork	2
34	C75034019100	shift fork shaft	2
35	C0402080200	needle roller D8x20	3
36	C90734036044	shifter rod cpl.	1
37	0738060205S	Oval head screw ISR M6x20-A2-70-MK	1
38	0738060165S	Rnd. hd. scr. TX M6x16 A2-70 S	1

69190

\* NEW PART

X ON DEMAND

# SHIFTING MECHANISM

Motor 790 Duke 2024

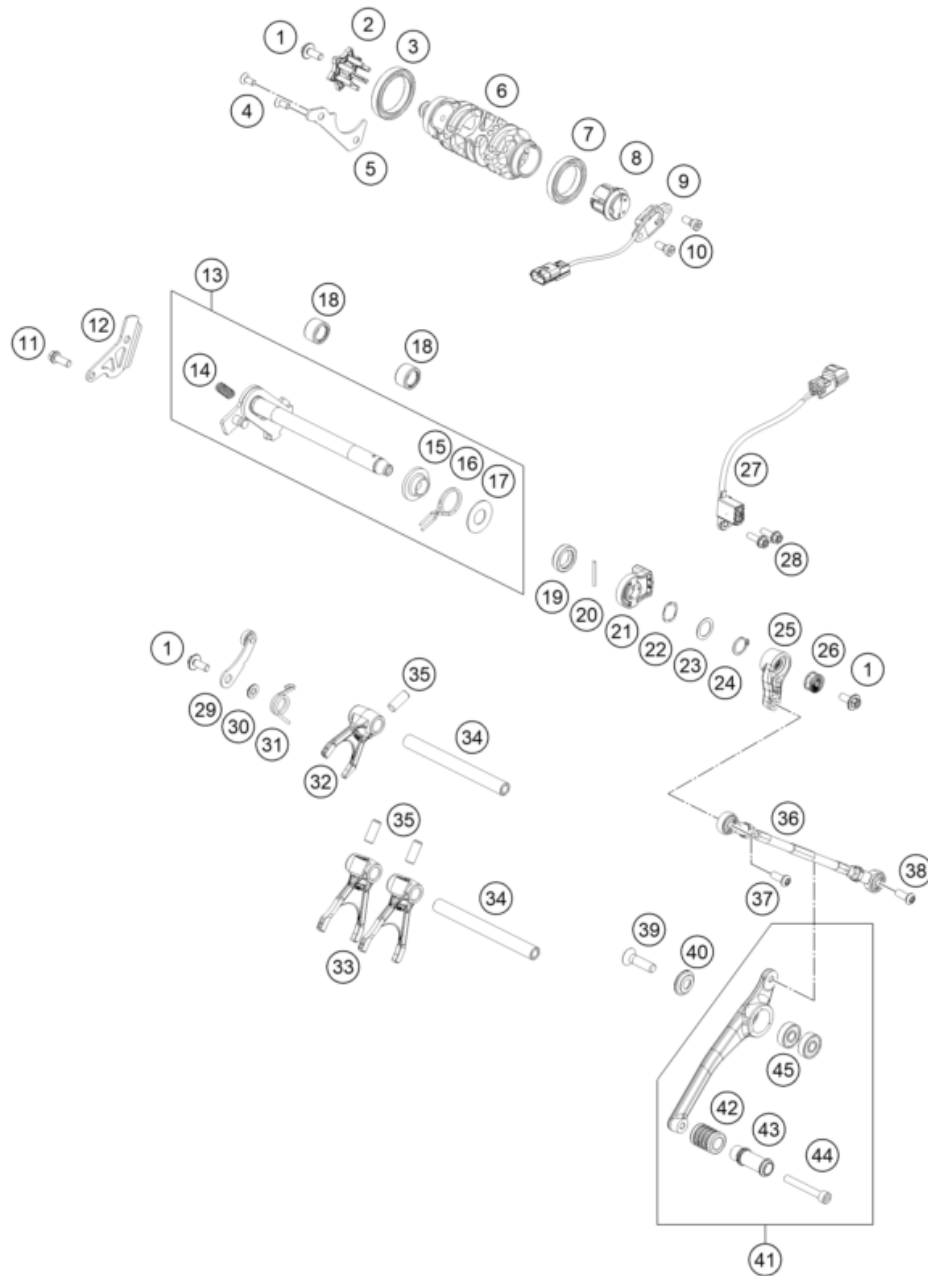

POS	PARTNUMBER		PIECE
39	C0000190803000S	COUNTER-SUNK SCREW ISA45 M8X30	1
40	C90734031020	Fasson Disc D=23x5	1
41	C90734031044C1	Gear lever kpl. black	1
42	C90734035000	Rubber Protector	1
43	C90734032100	Gear lever	1
44	C0047620604500S	Cylinderscrew ISO 4762-M6x45-8.8-MK	1
45	C0410000800700	Bearing 608 2RS	2

206353411

69190

\* NEW PART

X ON DEMAND

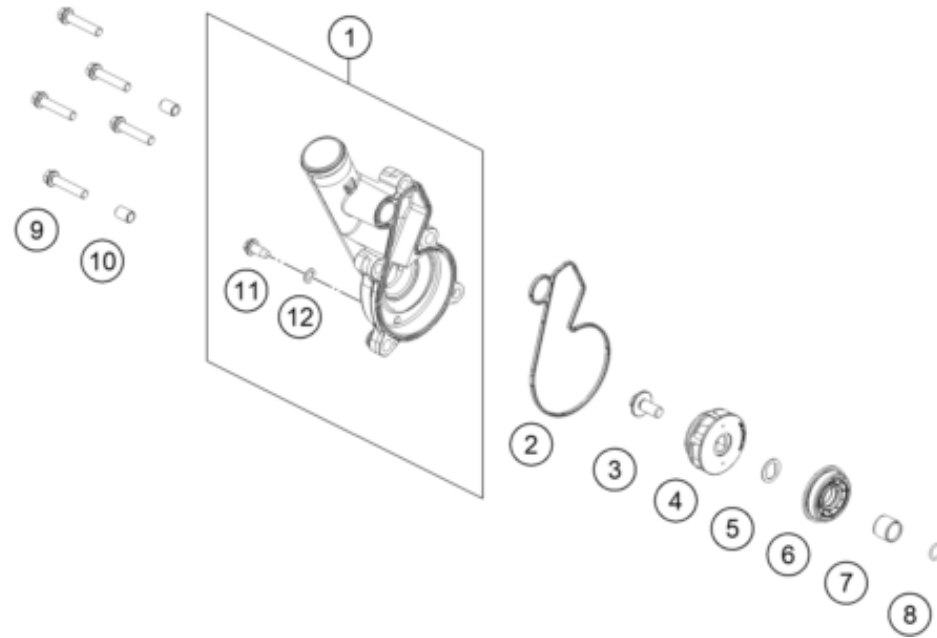

POS	PARTNUMBER		PIECE
1	C9003505200041	water pump cover	1
2	C90035053100	water pump cover gasket	1
3	C0000240601300S	HH Collar screw M6x13 TX30 SL	1
4	C90035055000	Water pump impeller compl.	1
5	C60035055150	double-d washer 16x1 SST	1
6	0760153459	radial shaft seal 34.5x15x9 Duo	1
7	C77236072120	Wear bushing 12/15/12,5	1
8	C07700900151	O-RING 9x1,5 V80 SH	1
9	C0000250603000S	SK-Bundschrabe M6x30 ISA30	5
10	C90030024000	Dowel	2
11	C0000250601200	HH collar screw M6x12 TX30	1
12	C0603061002	Seal ring 6/10/1	1

186353510

69093

\* NEW PART

X ON DEMAND

# COOLING SYSTEM

# Motor 790 Duke 2024

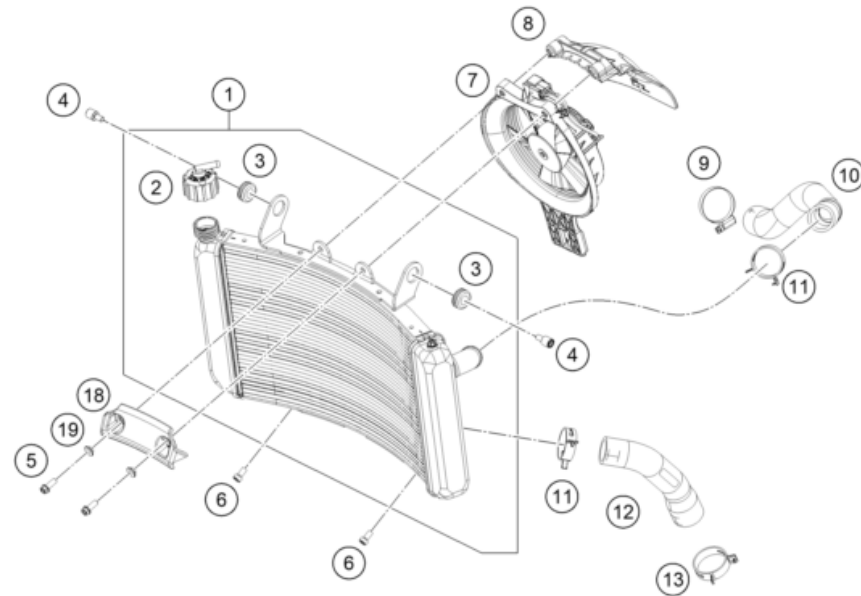
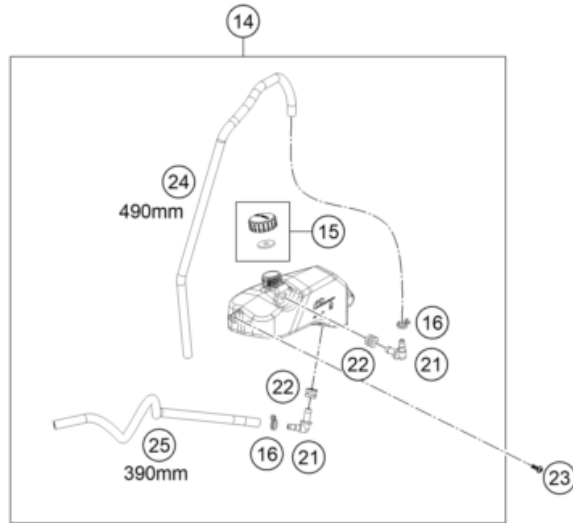

POS	PARTNUMBER		PIECE
1	63635010100	Radiator	1
2	62535009000	RADIATOR CAP 1,4 BAR	1
3	41001052000	RUBBER SLEEVE D=12MM	2
4	69035001000	STUD BOLT M6 11X11 ISA45	2
5	0025060166S	HH collar screw M6x16 TX30 SL	2
6	C014580060126S	Cap head bolt ISO 14580 M6x16 self-lock.	2
7	64135044033	Fan cover cpl.	1
8	63635042000	Air deflector, radiator	1
9	10001120000	CLAMP 25-40 SGT 4	1
10	C90735027000	Pre-formed hose radiator	1
11	C0310001229300	CLAMP STD DN32	2
12	C90735026000	Pre-formed hose radiator	1
13	C0310001234500	Spring band clamp STD DN38	1
14	C90735065033	Reservoir complete	1
15	C90735066044	expansiontank plug cpl	1
16	C90707017000	YDNAC-CLAMP 10107 10MM	2
18	64135032100	Edge protection radiator	1
19	69004060150	bushing chain protection	2
21	C90735068000	Angle connection expans. Tank	2
22	C90703065000	rubber insert	2
23	0081040121	EJOT Delta PT K40x12	1
24	C90735067490	hose 6x10 l=490	1
25	C90735067390	hose 6x10 l=390	1

226363530

59498

\* NEW PART

X ON DEMAND

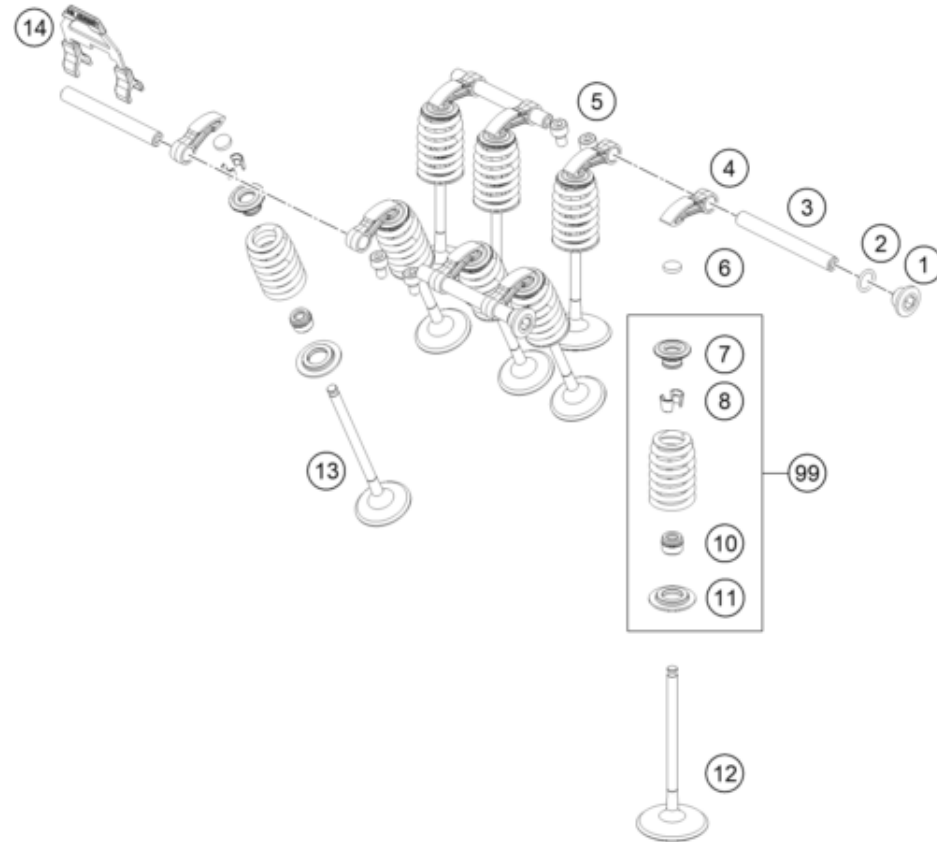

POS	PARTNUMBER		PIECE
1	77236080000	screw plug	2
2	C07700900151	O-RING 9x1,5 V80 SH	2
3	C63536056000	cam follower shaft	4
4	63536060000	Cam follower	8
5	C0912050083	Cap head screw, ISO 14579, M5x8-10.9	4
6	C77036035172	SHIM D=8,9/1,72	x
6	C77036035176	SHIM D=8,9/1,76	x
6	C77036035180	SHIM D=8,9/1,80	x
6	C77036035184	SHIM D=8,9/1,84	x
6	C77036035188	SHIM D=8,9/1,88	x
6	C77036035192	SHIM D=8,9/1,92	x
6	C77036035196	SHIM D=8,9/1,96	x
6	C77036035200	SHIM D=8,9/2,00	x
6	C77036035204	SHIM D=8,9/2,04	x
6	C77036035208	SHIM D=8,9/2,08	x
6	C77036035212	SHIM D=8,9/2,12	x
6	C77036035216	SHIM D=8,9/2,16	x
6	C77036035220	SHIM D=8,9/2,20	x
6	C77036035224	SHIM D=8,9/2,24	x
6	C77036035228	SHIM D=8,9/2,28	x
6	C77036035232	SHIM D=8,9/2,32	x
6	C77036035236	SHIM D=8,9/2,36	x
6	C77036035240	SHIM D=8,9/2,40	x
6	C77036035244	SHIM D=8,9/2,44	x
6	C77036035248	SHIM D=8,9/2,48	x
6	C77036035252	SHIM D=8,9/2,52	x
6	C77036035256	SHIM D=8,9/2,56	x
6	C77036035260	SHIM D=8,9/2,60	x
7	C90036032100	valve spring retainer	8
8	C90036033000	valve collet	16
10	C90036027100	valve stem seal	8
11	C90036036000	Seat valve spring	8
12	C90036030000	Intake valve	4
13	C90036031000	exhaust valve	4
14	C90036056050	cam follower clip	1
99	C90036028044	Repair kit countershaft	x

186353610

59505

\* NEW PART

X ON DEMAND



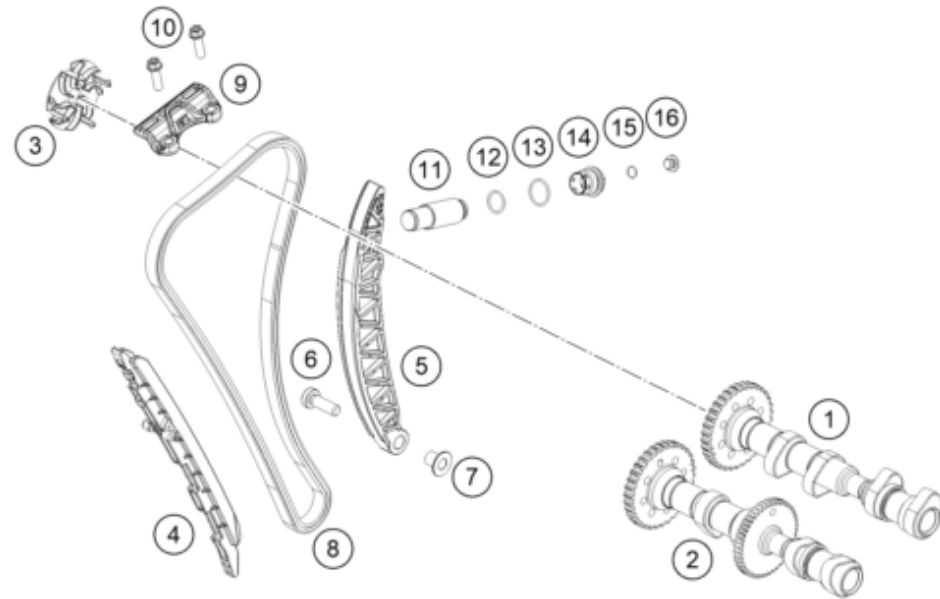

POS	PARTNUMBER		PIECE
1	C90036009044	Intake Camshaft	1
2	C90036010044	Exhaust Camshaft	1
3	C90036080000	venting centrifuge	1
4	63536001000	slide bars	1
5	63536002100	Tension Rail	1
6	C0000350802500S	ISA collar screw M8x25 ISA45	1
7	C63536002150	Collar bush d8xD10x13.2	1
8	63536013100	Timing chain	1
9	63536005000	slide bars, top cpl.	1
10	C0000250602000S	HH collar screw M6x20 TX30	2
11	77036003100	chain tension adjuster	1
12	C0770180020	o-ring 18.00x2.00 NBR70	1
13	C0770220020	o-ring 22.00x2.00 NBR70	1
14	C61236008201	chain tension adjuster plug	1
15	C0770010010	o-ring 10.00x1.00 NBR70	1
16	77236080000	screw plug	1

186353620

69195

\* NEW PART

X ON DEMAND

# CYLINDER HEAD

# Motor 790 Duke 2024

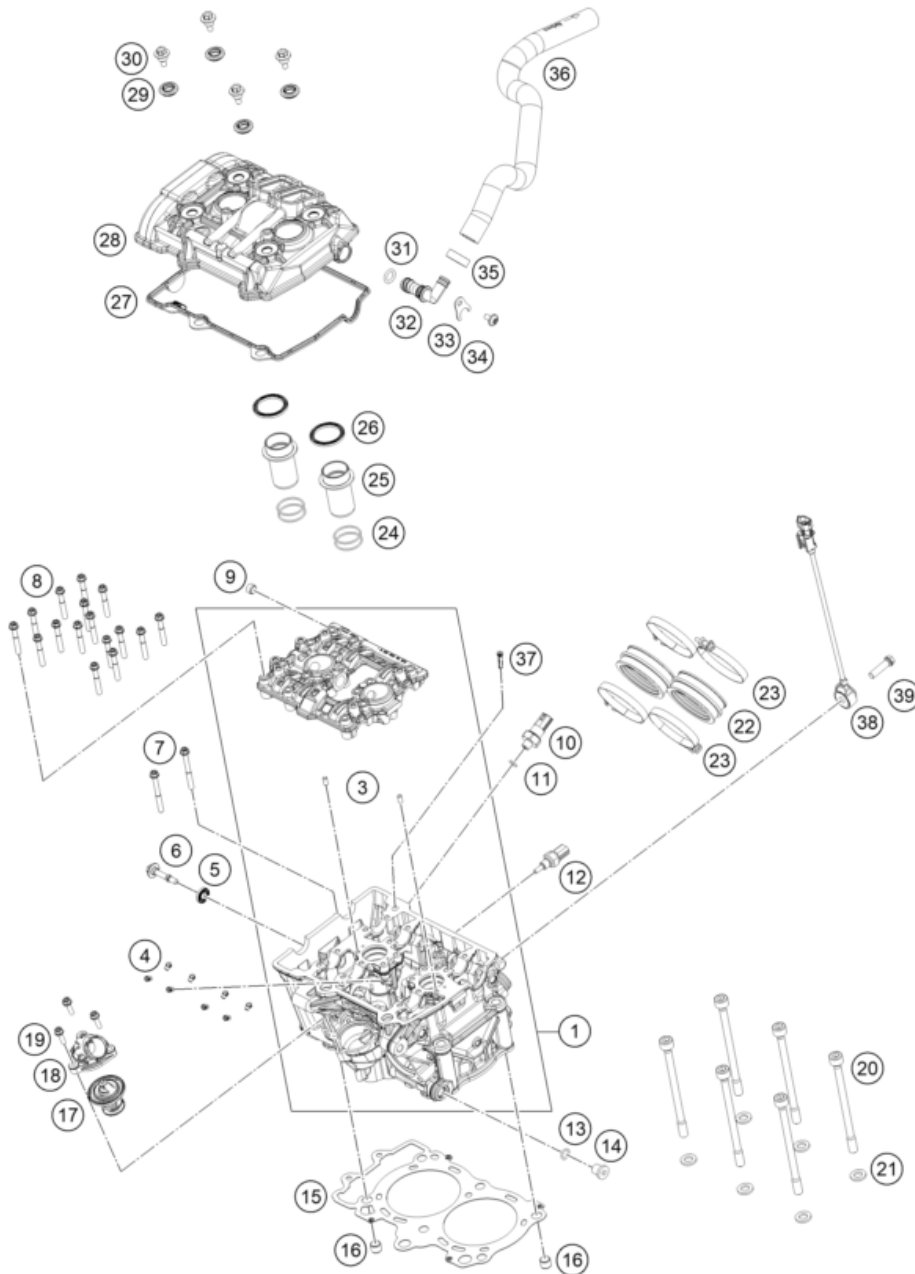

POS	PARTNUMBER		PIECE
1	C9003622010024	cylinder head cpl.	1
3	C0402050980	needle roller DIN 5402 5x9.8	2
4	C90030063050	oil jet 50 M5	8
5	C90036052010	decoupling element	1
6	C90036055000	valve mechanism cover screw	1
7	C0000250605500	SK-Bundschrabe M6x55 ISA30	2
8	0025060405	HH collar screw M6x40 ISA30	16
9	0906100100	pipe plug DIN 906 M10x1	1
10	61238091100	oil pressure switch "BITRON"	1
11	C07700900151	O-RING 9x1,5 V80 SH	1
12	C90035047000	water temperature sensor	1
13	C0770100020	o-ring 10.00x2.00 silicone	1
14	C0908120153	Screw M12x1.5	1
15	C90030036300	Cylinder head gasket	1
16	C58530014100	dowl sleeve 10.2x12.5x10	2
17	C90035117000	Thermostat BING 205-66	1
18	C63635019000	Water connection	1
19	C0000250501600S	HH Collar Screw M5x16 ISA30 SS	3
20	C78630044000	cylinder head bolt M10x1.25 L=138	6
21	C90036089010	washer 19x10.5x2.5	6
22	C90036144000	Intake Sleeve	2
23	C61236048000	hose clamp Gemi 66	4
24	C0770298178	O-RING 29,87X1,78 VITON	4
25	C63536075000	spark plug shaft insert	2
26	C90036075050	spark plug shaft gasket	2
27	C90036053000	Valve cover seal	1
28	C9003605200033	valve cover	1
29	C90036054160	RUBBER GASKET FOR SCREW	4
30	C90036054150	VALVE COVER SCREW	4
31	C0770012030	O-RING 12,00X3,0 VITON 75	1
32	C90036081000	bleeder connector	1
33	C63736082050	bleeder flange retaining plate	1
34	C0000250601200	HH collar screw M6x12 TX30	1
35	C00050198706	variable one-year clamp 19.8mm	1
36	C64630087000	enigne breather hose	1
37	C90038016000	Oil screen	1
38	63641038000	Knock control sensor	1
39	C0000250803000	HH collar screw M8x30	1

226353630

69092

\* NEW PART

X ON DEMAND

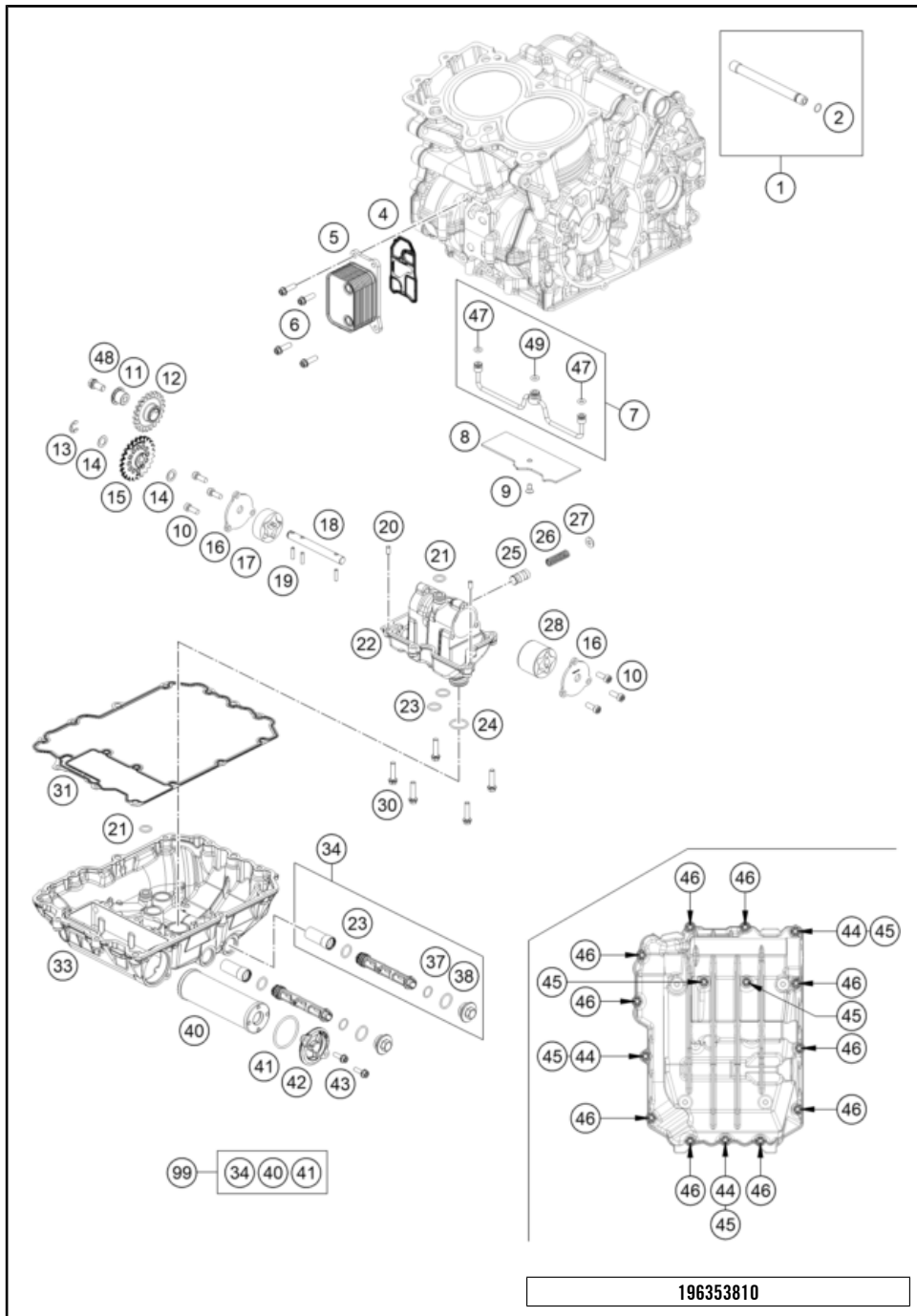

POS	PARTNUMBER		PIECE
1	63530065000	Gearbox lubrication pipe cmpl.	1
2	C0770010010	o-ring 10.00x1.00 NBR70	1
4	C90038051000	gasket with support sheet	1
5	C90038050000	oil-water-heater exchanger	1
6	C0000250602000S	HH collar screw M6x20 TX30	4
7	C90038035000	oil line	1
8	C63530086010	pressure plate	1
9	C0000190501200S	INT. TORX FLAT HEAD M5X12 T25	1
10	C014580060126S	Cap head bolt ISO 14580 M6x16 self-lock.	6
11	C63638003000	Bearing bolt	1
12	C90038001022	oil pump idler wheel 22 teeth cpl.	1
13	C0799080000	Lock washer DIN 6799 - RS 8	1
14	C90038007010	washer 10x16x0.5	1
15	C90038001224	Oil pump gear 24T	1
16	C90038008050	Oil pump cover	2
17	C90038009014	Eaton pump set 14 mm	1
18	C90038002000	Oil pump shaft	1
19	C0402041580	Needle roller 4x15.8 G2 NRB	3
20	C0402050980	needle roller DIN 5402 5x9.8	2
21	C0770120020	O-ring 12x2	2
22	C90038012000	Oil pump housing	1
23	C0770140200	O-ring 14x2	4
24	C0770020020	O-ring 20x2 VITON	1
25	C90038128000	Control piston	1
26	C90038026000	Oil compression spring	1
27	C90037073000	Shim	1
28	C90038010000	Eaton pump set 30 mm	1
30	C0000250602500	SK-Bundschraube M6x25 ISA30	5
31	C90030086100	Oil sump gasket	1
33	C9003008500024	oil pan	1
34	61238021200	Oil screen cmpl.	2
37	0770125015	O-RING 12,5X1,5 NBR	2
38	0770170200	O-RING 17,00X2,00	2
40	C90038015200	oil filter	1
41	C07700390261	O-RING 39,34X2,62	1
42	C90038041200	oil filter cover	1
43	C0000250501600	SK-Bundschraube M5x16 ISA30	2
44	C90030024000	Dowel	3

\* NEW PART X ON DEMAND

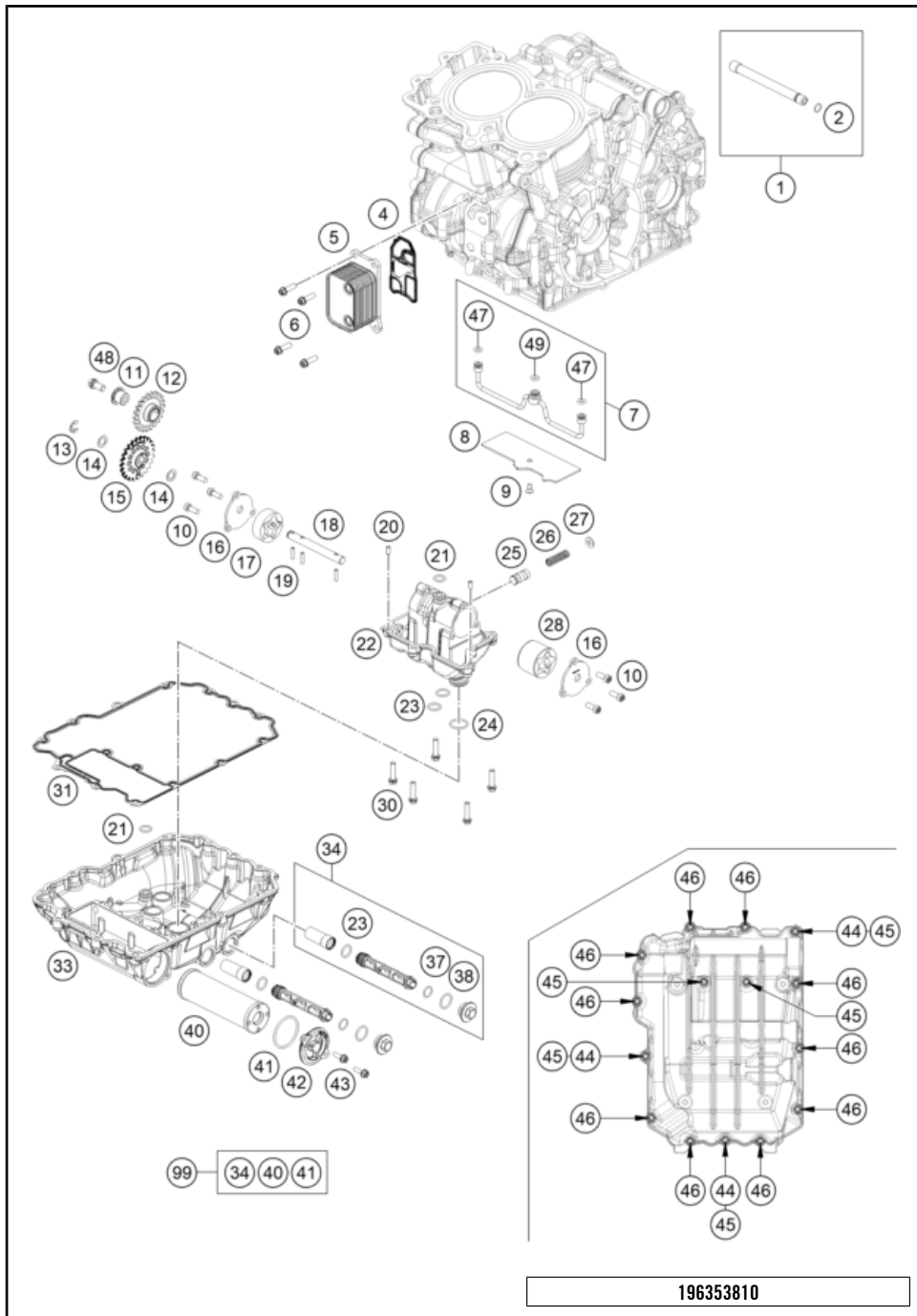

POS	PARTNUMBER		PIECE
45	C0000250603500	SK-Bundschraube M6x35 ISA30	5
46	C0000250603000	SK-Bundschraube M6x30 ISA30	10
47	C0770060025	O-ring 6x2,5	2
48	C0000250801600S	HH collar screw M8x16 TX40 SL	1
49	C0770070025	O-ring 7x2,5	1
99	C00050000068	Oil filter service kit	x

\* NEW PART X ON DEMAND

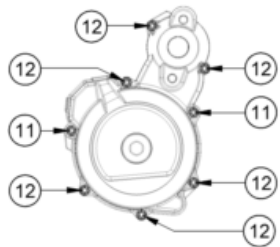
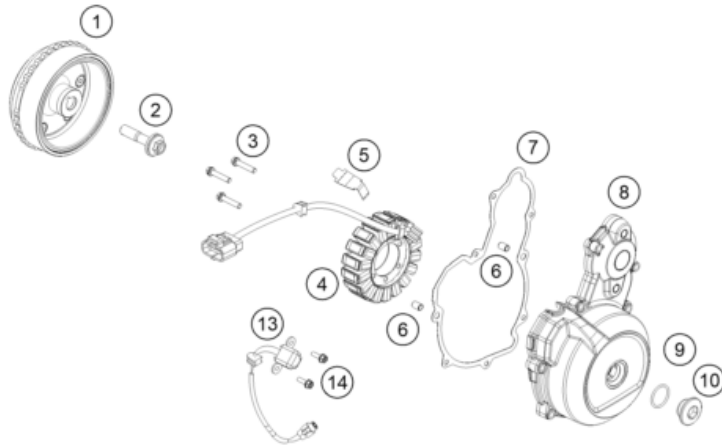
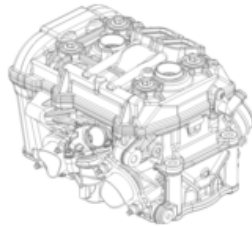
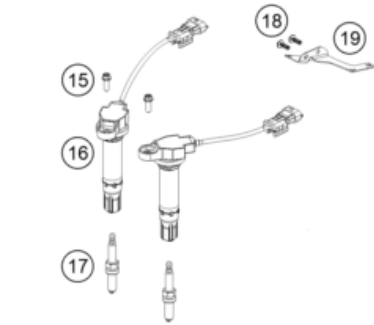

POS	PARTNUMBER		PIECE
1	C90039105000	rotor cpl.	1
2	C60339003000	special screw M12x1.5 WS15	1
3	C0000250603000S	SK-Bundschrabe M6x30 ISA30	3
4	C90039004000	stator	1
5	C60039040020	generator line bracket	1
6	C90030024000	Dowel	2
7	C90030040100	ignition cover gasket	1
8	C9003010200041	Generator Cover KTMR2R only for CN	1
8	C9003020200041	Generator Cover	1
9	C07700240251	o-ring 24.00x2.50 Viton	1
10	C90030094000	threaded plug M24x1.5 PA 6.6	1
11	C0000250603500	SK-Bundschrabe M6x35 ISA30	2
12	C0000250603000	SK-Bundschrabe M6x30 ISA30	6
13	C90039034000	pulse generator KOKUSAN 4K3-A/B	1
14	C0000250501600S	HH Collar Screw M5x16 ISA30 SS	2
15	C0000250601600S	HH collar screw M6x16 TX30 SL	2
16	C90039006100	Stick coil	2
17	77839093000	spark plug	2
18	0081050141	EJOT PT screw K50x14	2
19	C64111038000	Halteblech Stickcoilstecker	1

216353911

69091

\* NEW PART

X ON DEMAND

# ELECTRIC STARTER

# Motor 790 Duke 2024

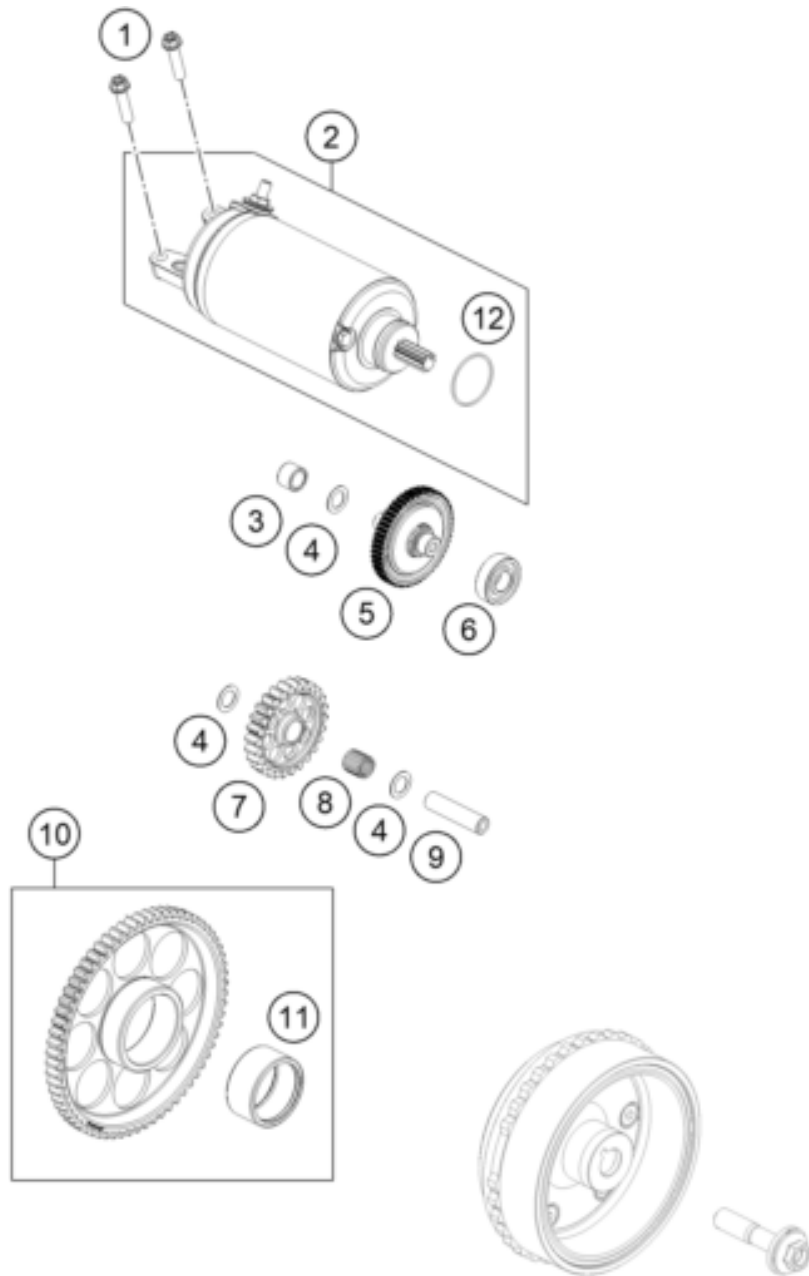

POS	PARTNUMBER		PIECE
1	C0000250602500	SK-Bundschraube M6x25 ISA30	2
2	C90040001000	starter	1
3	C0618101410	needle sleeve HK 1010 10x14x10	1
4	C90038007010	washer 10x16x0.5	3
5	60340117200	Torque limiter 10/55 cml.	1
6	C0625060016	deep groove ball bearing 6001.2RSR C3	1
7	C90040022000	Starter idler gear 26T	1
8	C90040090000	needle roller and cage K 10x13x13 TN	1
9	C63540029000	pivot pin	1
10	63540020000	free wheel gear cpl.	1
11	0618354220	NEEDLE BUSH HK3520 35/42/20	1
12	C0770244031	O-ring 24.40x3.10 NBR 70	1

186354010

59512

\* NEW PART

X ON DEMAND

# THROTTLE BODY

# Motor 790 Duke 2024

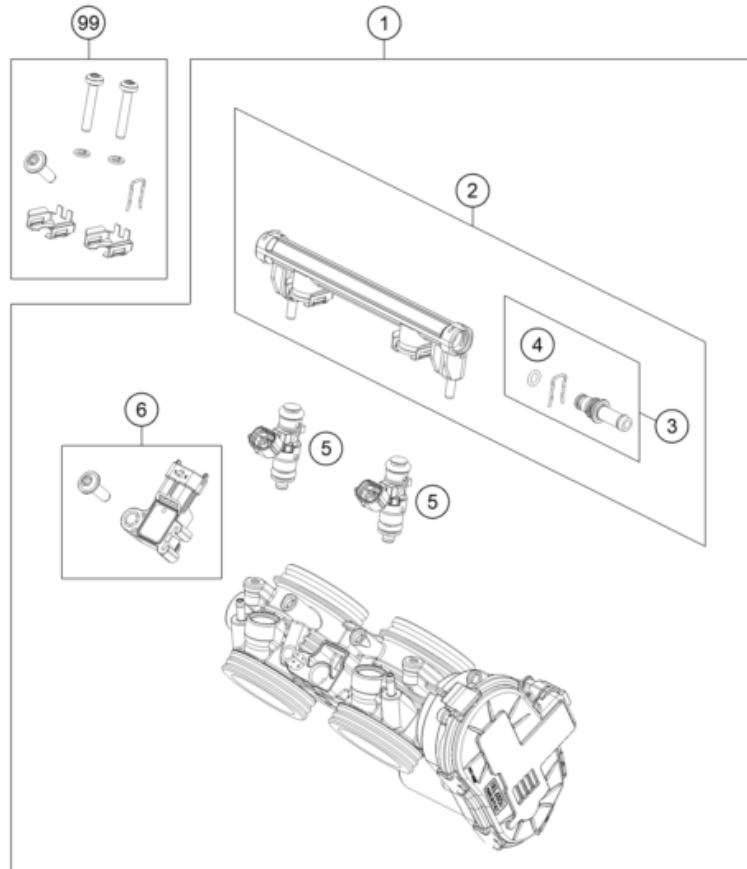

POS	PARTNUMBER		PIECE
1	A65441001000	Throttle body	1
2	63541013050	Fuel pipe	1
3	63541013044	Fuel connector cmpl.	1
4	63541013010	Square and dust seal	1
5	90841123000	FUEL INJECTOR	2
6	63641085044	MAP sensor, cmpl.	1
7	61236048000	hose clamp Gemi 66	4
8	C90036144000	Intake Sleeve	2
9	0912040163S	AH screw DIN0912 M4x16 self-locking	4
10	63541031100	EFI control unit	1
11	C90741030010	Collar bushing 4.5x6x12x6.3	4
12	C90741030000	Rubber band control unit	4
13	C90741029000	Mounting Bracket ECU cpl.	2
99	63641099000	Smallpart kit	1

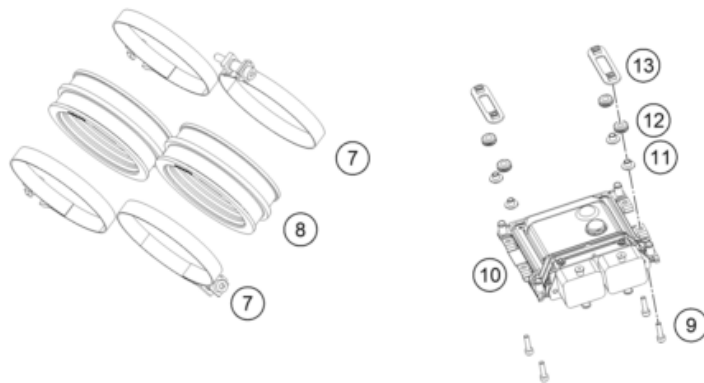

186354110

59513

\* NEW PART

X ON DEMAND

A large, empty rectangular box with a thin black border, occupying the majority of the page. It is intended for the user to write their notes.



A large, empty rectangular box with a thin black border, occupying the majority of the page. It is intended for the user to write their notes.

A large, empty rectangular box with a thin black border, occupying the majority of the page. It is intended for the user to write their notes.



# KTM.COM



P2C9006R00K24EN

KTM Sportmotorcycle GmbH  
5230 Mattighofen, Austria  
[www.ktm.com](http://www.ktm.com)

**KTM** POWERPARTS

**KTM** POWERWEAR

**KTM** ORIGINAL SPARE PARTS



Art. Nr.: P2C9006R00K24EN 23. Nov 2023